

Linus 150

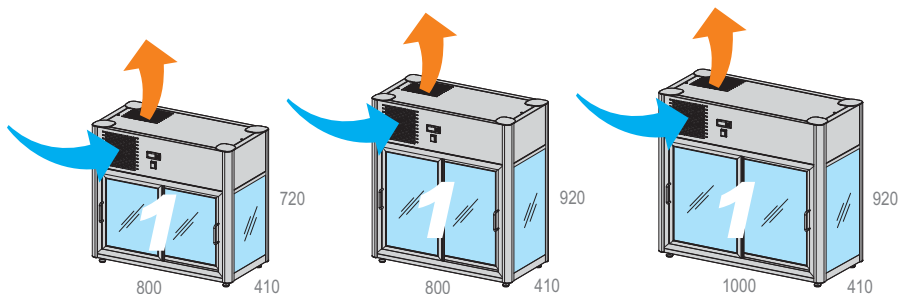

Struttura inox + alluminio lucido
 Stainless steel frame + polished aluminium
 Structure inox + aluminium brillant
 Inox Struktur + Aluminium weiß
 Estructura en acero inox + aluminio lustroso



Linus 100	Lt. 100	Watt 320	n. 1 mm. 685x292	°C +4/+10	% U.R. 70		230v/1/50Hz		R404a	Kg. 70
Linus 150	Lt. 160	Watt 320	n. 2 mm. 685x292	°C +4/+10	% U.R. 70		230v/1/50Hz		R404a	Kg. 85
Linus 200	Lt. 200	Watt 320	n. 2 mm. 899x292	°C +4/+10	% U.R. 70		230v/1/50Hz		R404a	Kg. 95

Dati di collaudo • Test details • Détails d'essai • Prüfungsergebnisse • Datos de ensayo • MAX = (25°C - % U.R. 60)

GOLOSO

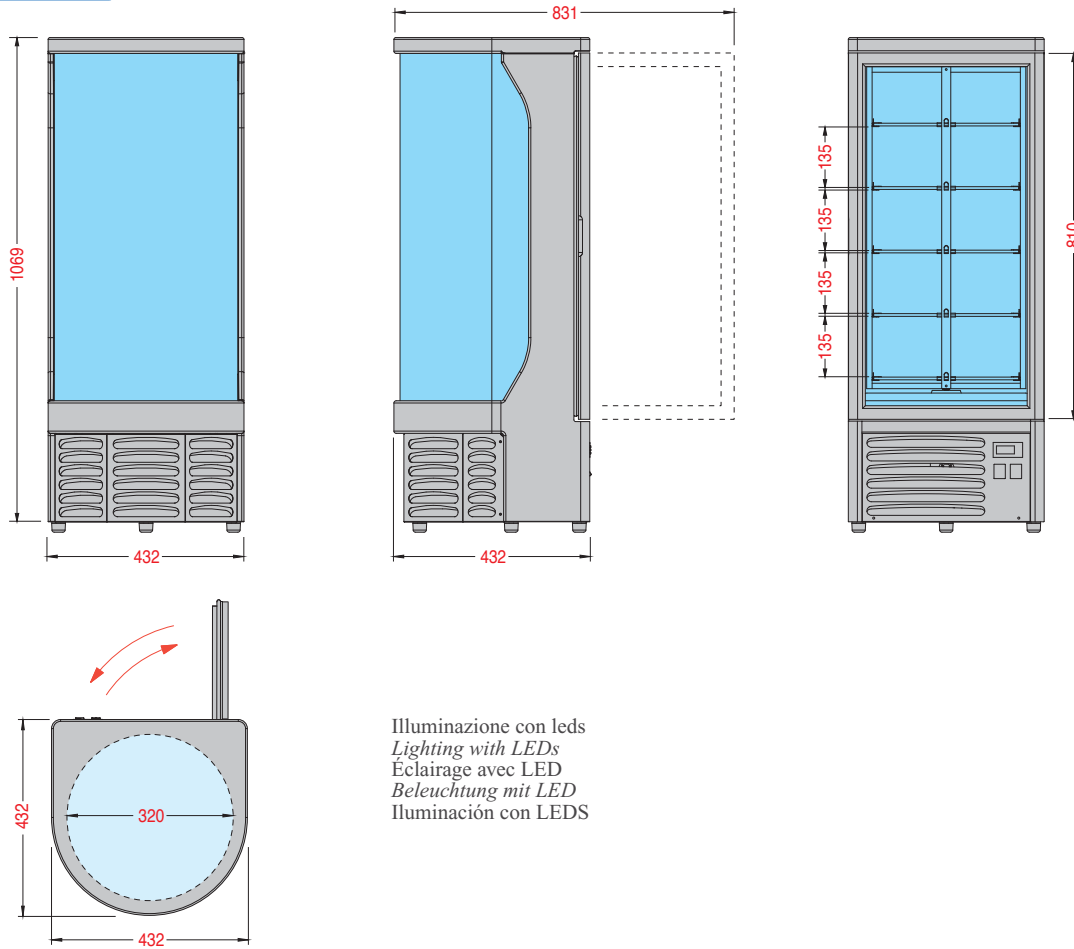

LINUS 642 DRY

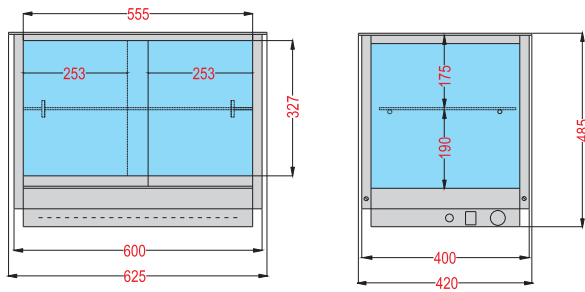

LINUS 842 DRY

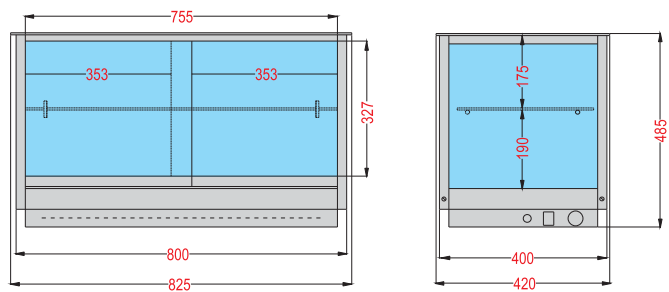

LINUS 1042 DRY

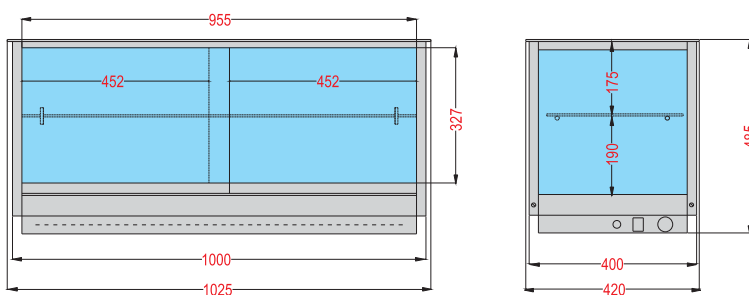

LINUS 100

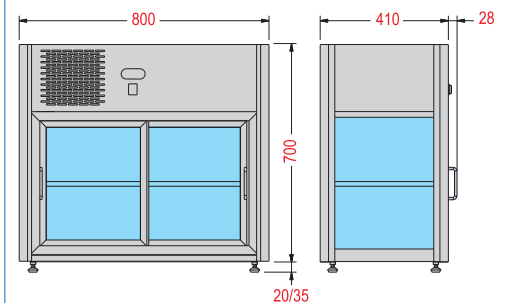

ORIZONT 202 Q Hot

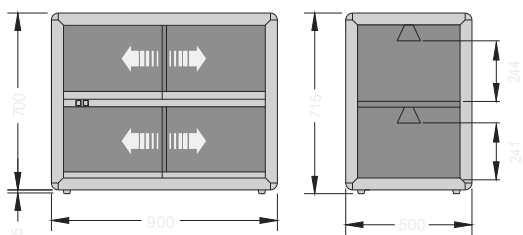

ORIZONT 200 Q

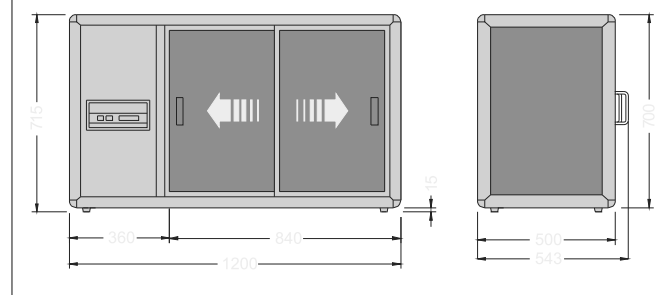

al

