

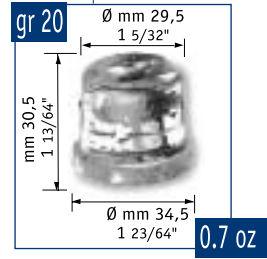

- AC 46
- AC 56
- AC 86
- AC 106
- AC 126
- AC 176**
- AC 206
- AC 226

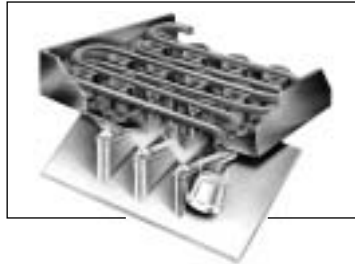

KITLEGSEX000

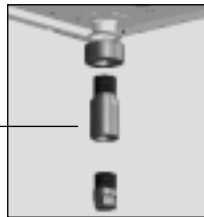

Available as optional

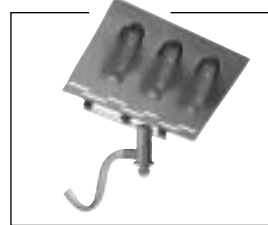

Spray bar quick disconnect



Patented anti-scale system

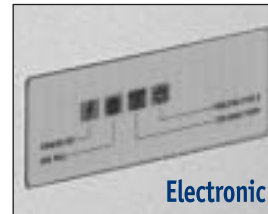

Electronic

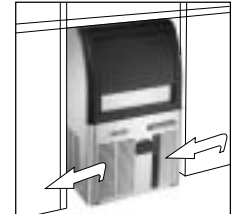

Condenser air filter



Front ON - OFF switch



Hygienic scoop holder



Storage bin antibacterial pouch holder

**Automatic
Gourmet-Cube
Ice Machine**

**Machine
Automatique
à Glaçons
Gourmet**

**Automatischer
Gourmetkegel-
eisbereiter**

**Màquina
Automàtica
Fabricadora
de Cubitos
Gourmet**

**Produttore
Automatico
di Ghiaccio
a Cubetti
Gourmet**

Model	Temperature Range	Production Capacity (per hour)						Dimensions (mm)	Dimensions (inches)	Weight (kg)	Voltage/Ph	Compressor	
		10°:10°C	21°:15°C										
		[kg]	[lbs]	N°*	[kg]	[lbs]	N°*	[WxDxH mm]	[WxDxH inches]				
AC 176 AS	+C° -C°	83	184	4175	78	172	3900	680x600x1000/1120	26x23x39/44	48	106/2400	230/50/1	R 404 a
AC 176 WS		85	187	4250	78	172	3900	680x600x1000/1120	26x23x39/44	48	106/2400	230/50/1	R 404 a

*Estimate number of medium/large size gourmet cubes.
Standard legs 120 mm high included.
Leg extension 60 mm high available as code no. KITLEGSEX000.
Optional: PWD System.

www.scotsman-ice.com
www.scotsman-ice.it

2

**Years Warranty
Ans de Garantie
Jahre Garantie
Años de Garantía
Anni di Garanzia**

Subject to certain limitations and exclusions
Assujettie aux limites et exclusions prescrites
Abhängig von Bestimmten Einschränkungen und Ausnahmen
Sujeta a algunas limitaciones y exclusiones
Soggetta ad alcune limitazioni ed esclusioni



AC 176

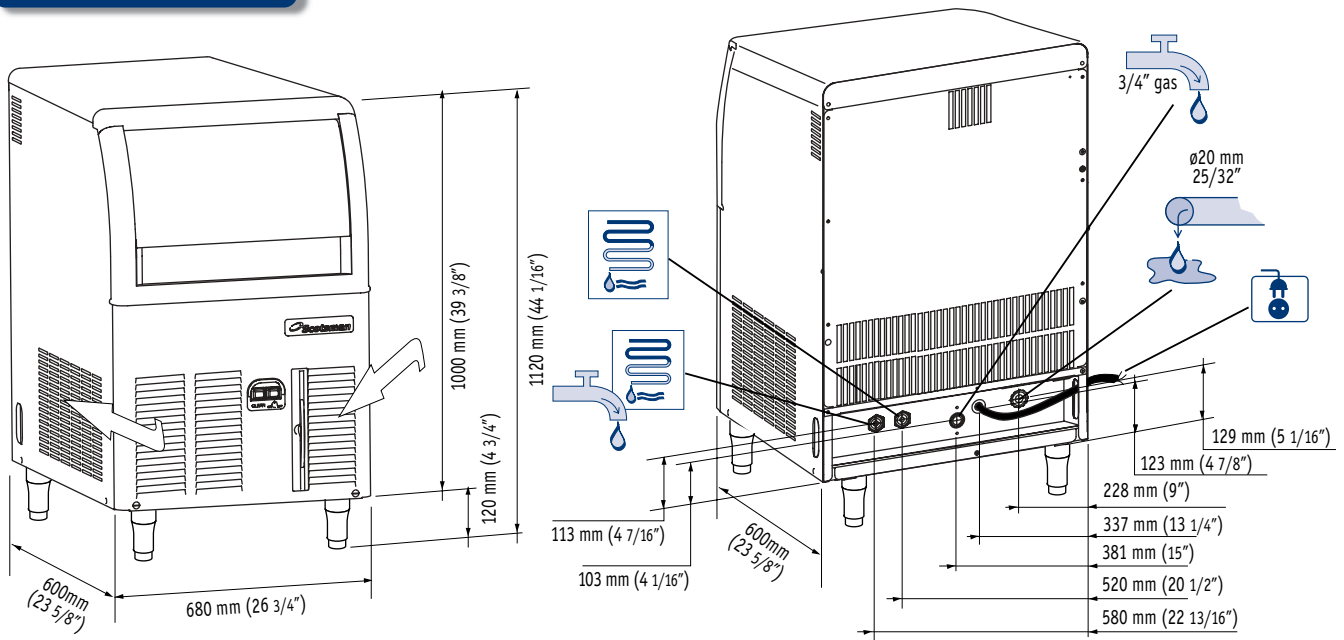

AC 176 AS		7850 2300	3 x 1.5	700	10	16.8	6.2 1.6	70 154	80 176		
AC 176 WS		7850 2300	3 x 1.5	700	10	15.3	73 19.3	70 154	80 176		

AC 176 AIR COOLED



°C \ °F	50° 10°	60° 15°	70° 21°	90° 32°	
10°	83.5	81	78.5	73.5	kg
50°	184	179	173	162	lbs
21°	80.5	78	75.5	73.5	kg
70°	177.5	172	166	155	lbs
32°	74	71.5	69	64	kg
90°	163	158	152	141	lbs
38°	68.5	66	63.5	58.5	kg
100	151	145.5	140	129	lbs



Machine requires voltage indicated on rating name plate. Failures caused by improper voltage are not considered factory defects. Scotsman products are not designed for outdoor installation. Extended periods of operation at temperatures exceeding the above limitations constitutes misuse under the terms of Scotsman Limited Warranty, resulting in a loss.

AC 176 WATER COOLED



°C \ °F	50° 10°	60° 15°	70° 21°	90° 32°	
10°	85	83	81	77	kg
50°	187	183	179	170	lbs
21°	80	78	76	72	kg
70°	176	172	167.5	159	lbs
32°	72	70	68	64	kg
90°	159	154	150	141	lbs
38°	70	68	66	62	kg
100	154	150	145.5	137	lbs



La machine doit être raccordée conformément au voltage indiqué sur la plaque signalétique. Les éventuels dégâts causés par un non respect de cette consigne ne peuvent être considérés comme des défauts de fabrication. Les machines à glace Scotsman ne sont pas conçues pour être utilisées à l'extérieur. Le fonctionnement prolongé à des températures supérieures ou inférieures aux limites ci-dessus sont considérées comme une mauvaise utilisation dans le cadre de la garantie Scotsman.

Der Eisbereiter benötigt eine Stromspannung gemäß Geräte-Typenschild. Störungen oder Ausfälle, durch den Betrieb mit falscher Stromspannung sind keine Fabrikationsfehler und fallen nicht unter Garantie. Scotsman Eisbereiter sind nicht für die Installation im Freien geeignet. Der längere Betrieb bei Temperaturen über den obigen Grenzwerten ist eine falsche Anwendung und bedeutet den Verlust der Garantieleistung.

Los requerimientos eléctricos de la máquina están indicados en la placa de características. Los daños causados por voltajes inadecuados no son considerados defectos de fábrica. La máquina de hielo Scotsman, no están diseñadas para trabajar a la intemperie. Largos periodos de funcionamiento a temperaturas que excedan de las limitaciones indicadas, constituyen maltrato de acuerdo con las observaciones de Scotsman.

La macchina richiede il voltaggio indicato sulla targhetta di identificazione. Danni causati da voltaggi diversi non sono considerati difetti di produzione. I prodotti Scotsman non vanno utilizzati all'aperto. Un prolungato periodo di utilizzo al di fuori delle temperature indicate non è consentito e causa l'automatico decadere della garanzia.



Minimum

10°C (50°F)



Maximum

40°C (104°F)

5°C (41°F)

-10%

1 BAR
14 psi

35°C (95°F)

+10%

5 BAR
70 psi



Scotsman[®]
Ice Systems

The one the world relies on.

Certified ISO 9001:2000

<p>USA, Canada, Latin America Scotsman Ice Systems USA 775 Corporate Woods Parkway Vernon Hills, IL 60061 Ph: (+1) 847 215-4550 Fax (+1) 847 913-9844 customer.service@scotsman-ice.com</p>	<p>Europe Scotsman Europe-Frimont S.p.A. Via Puccini, 22 20010 Pogliano (Milano) Italy Ph: (+39) 02-93960208 Fax: (+39) 02-93960201 scotsman.europe@frimont.it</p>	<p>Asia and Pacific Scotsman Ice Systems-Frimont S.p.A. (R.O.) 627A Aljunied Road #04-04 Biztech Centre Singapore 389842 Ph: (+65) 6738 5393 Fax: (+65) 6738 1959 scotsice@singnet.com.sg</p>	<p>China Scotsman Ice Systems (Shanghai) Co., Ltd Room 405-407 Jing'an China Tower 1701 West Beijing Road-200040 Shanghai Ph: (+86) 21-62476056-Fax: (+86) 21-62476126 scotsmarsh@online.sh.cn</p>	<p>Middle East & N. Africa Scotsman Ice Systems Dubai Office P.o. Box 21648 Sharjah - U.A.E. Mobile: Ph: (+971) 505505980 Fax (+971) 6-5654063 scotsman@eim.ae</p>	<p>South Africa Scotsman Ice Systems SA (PTY) Ltd. 10, Rhodes Street - Kensington B P.o. Box 44 - Riverclub 2149 Ph: (+27) 11-7898400 Fax (+27) 11-7898411 scotsman@telkomsa.net</p>
--	---	--	---	---	---